

LM2674 SIMPLE SWITCHER® Power Converter High Efficiency 500 mA Step-Down Voltage Regulator

General Description

The LM2674 series of regulators are monolithic integrated circuits built with a LDMOS process. These regulators provide all the active functions for a step-down (buck) switching regulator, capable of driving a 500 mA load current with excellent line and load regulation. These devices are available in fixed output voltages of 3.3V, 5.0V, 12V, and an adjustable output version.

Requiring a minimum number of external components, these regulators are simple to use and include patented internal frequency compensation (Patent Nos. 5,382,918 and 5,514,947) and a fixed frequency oscillator.

The LM2674 series operates at a switching frequency of 260 kHz, thus allowing smaller sized filter components than what would be needed with lower frequency switching regulators. Because of its very high efficiency (>90%), the copper traces on the printed circuit board are the only heat sinking needed.

A family of standard inductors for use with the LM2674 are available from several different manufacturers. This feature greatly simplifies the design of switch-mode power supplies using these advanced ICs. Also included in the datasheet are selector guides for diodes and capacitors designed to work in switch-mode power supplies.

Other features include a guaranteed $\pm 1.5\%$ tolerance on output voltage within specified input voltages and output load conditions, and $\pm 10\%$ on the oscillator frequency. External shutdown is included, featuring typically 50 μA stand-by current. The output switch includes current limiting, as well as thermal shutdown for full protection under fault conditions.

To simplify the LM2674 buck regulator design procedure, there exists computer design software, *LM267X Made Simple*.

Features

- Efficiency up to 96%
- Available in SO-8 and 8-pin DIP packages
- Computer Design Software *LM267X Made Simple*
- Simple and easy to design with
- Requires only 5 external components
- Uses readily available standard inductors
- 3.3V, 5.0V, 12V, and adjustable output versions
- Adjustable version output voltage range: 1.21V to 37V
- $\pm 1.5\%$ max output voltage tolerance over line and load conditions
- Guaranteed 500mA output load current
- 0.25 Ω DMOS Output Switch
- Wide input voltage range: 8V to 40V
- 260 kHz fixed frequency internal oscillator
- TTL shutdown capability, low power standby mode
- Thermal shutdown and current limit protection

Typical Applications

- Simple High Efficiency (>90%) Step-Down (Buck) Regulator
- Efficient Pre-Regulator for Linear Regulators
- Positive-to-Negative Converter

Typical Application

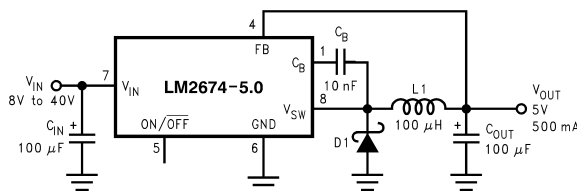

DS100041-1

SIMPLE SWITCHER® is a registered trademark of National Semiconductor Corporation.
Windows® is a registered trademark of Microsoft Corporation.

Absolute Maximum Ratings (Note 1)

If Military/Aerospace specified devices are required, please contact the National Semiconductor Sales Office/Distributors for availability and specifications.

Supply Voltage	45V
ON/OFF Pin Voltage	$-0.1V \leq V_{SH} \leq 6V$
Switch Voltage to Ground	-1V
Boost Pin Voltage	$V_{SW} + 8V$
Feedback Pin Voltage	$-0.3V \leq V_{FB} \leq 14V$
ESD Susceptibility	
Human Body Model (Note 2)	2 kV
Power Dissipation	Internally Limited

Storage Temperature Range	-65°C to +150°C
Lead Temperature	
M Package	
Vapor Phase (60s)	+215°C
Infrared (15s)	+220°C
N Package (Soldering, 10s)	+260°C
Maximum Junction Temperature	+150°C

Operating Ratings

Supply Voltage	6.5V to 40V
Junction Temperature Range	$-40^\circ\text{C} \leq T_J \leq +125^\circ\text{C}$

Electrical Characteristics Specifications with standard type face are for $T_J = 25^\circ\text{C}$, and those with **bold type face** apply over full Operating Temperature Range.

LM2674-3.3

Symbol	Parameter	Conditions	Typical (Note 4)	Min (Note 5)	Max (Note 5)	Units
SYSTEM PARAMETERS Test Circuit <i>Figure 2</i> (Note 3)						
V_{OUT}	Output Voltage	$V_{IN} = 8V$ to 40V, $I_{LOAD} = 20$ mA to 500 mA	3.3	3.251/ 3.201	3.350/ 3.399	V
V_{OUT}	Output Voltage	$V_{IN} = 6.5V$ to 40V, $I_{LOAD} = 20$ mA to 250 mA	3.3	3.251/ 3.201	3.350/ 3.399	V
η	Efficiency	$V_{IN} = 12V$, $I_{LOAD} = 500$ mA	86			%

LM2674-5.0

Symbol	Parameter	Conditions	Typical (Note 4)	Min (Note 5)	Max (Note 5)	Units
SYSTEM PARAMETERS Test Circuit <i>Figure 2</i> (Note 3)						
V_{OUT}	Output Voltage	$V_{IN} = 8V$ to 40V, $I_{LOAD} = 20$ mA to 500 mA	5.0	4.925/ 4.850	5.075/ 5.150	V
V_{OUT}	Output Voltage	$V_{IN} = 6.5V$ to 40V, $I_{LOAD} = 20$ mA to 250 mA	5.0	4.925/ 4.850	5.075/ 5.150	V
η	Efficiency	$V_{IN} = 12V$, $I_{LOAD} = 500$ mA	90			%

LM2674-12

Symbol	Parameter	Conditions	Typical (Note 4)	Min (Note 5)	Max (Note 5)	Units
SYSTEM PARAMETERS Test Circuit <i>Figure 2</i> (Note 3)						
V_{OUT}	Output Voltage	$V_{IN} = 15V$ to 40V, $I_{LOAD} = 20$ mA to 500 mA	12	11.82/ 11.64	12.18/ 12.36	V
η	Efficiency	$V_{IN} = 24V$, $I_{LOAD} = 500$ mA	94			%

LM2674-ADJ

Symbol	Parameter	Conditions	Typ (Note 4)	Min (Note 5)	Max (Note 5)	Units
SYSTEM PARAMETERS Test Circuit <i>Figure 3</i> (Note 3)						
V_{FB}	Feedback Voltage	$V_{IN} = 8V$ to 40V, $I_{LOAD} = 20$ mA to 500 mA V_{OUT} Programmed for 5V (see Circuit of <i>Figure 3</i>)	1.210	1.192/ 1.174	1.228/ 1.246	V
V_{FB}	Feedback Voltage	$V_{IN} = 6.5V$ to 40V, $I_{LOAD} = 20$ mA to 250 mA V_{OUT} Programmed for 5V (see Circuit of <i>Figure 3</i>)	1.210	1.192/ 1.174	1.228/ 1.246	V
η	Efficiency	$V_{IN} = 12V$, $I_{LOAD} = 500$ mA	90			%

All Output Voltage Versions

Electrical Characteristics

Specifications with standard type face are for $T_J = 25^\circ\text{C}$, and those with **bold type face** apply over **full Operating Temperature Range**. Unless otherwise specified, $V_{IN} = 12\text{V}$ for the 3.3V, 5.0V, and Adjustable versions and $V_{IN} = 24\text{V}$ for the 12V version, and $I_{LOAD} = 100\text{ mA}$.

Symbol	Parameters	Conditions	Typ	Min	Max	Units
DEVICE PARAMETERS						
I_Q	Quiescent Current	$V_{FEEDBACK} = 8\text{V}$ For 3.3V, 5.0V, and ADJ Versions	2.5		3.6	mA
		$V_{FEEDBACK} = 15\text{V}$ For 12V Versions	2.5			mA
I_{STBY}	Standby Quiescent Current	ON/OFF Pin = 0V	50		100/150	μA
I_{CL}	Current Limit		0.8	0.62/0.575	1.2/1.25	A
I_L	Output Leakage Current	$V_{IN} = 40\text{V}$, ON/OFF Pin = 0V $V_{SWITCH} = 0\text{V}$	1		25	μA
		$V_{SWITCH} = -1\text{V}$, ON/OFF Pin = 0V	6		15	mA
$R_{DS(ON)}$	Switch On-Resistance	$I_{SWITCH} = 500\text{ mA}$	0.25		0.40/0.60	Ω
f_O	Oscillator Frequency	Measured at Switch Pin	260	225	275	kHz
D	Maximum Duty Cycle		95			%
	Minimum Duty Cycle		0			%
I_{BIAS}	Feedback Bias Current	$V_{FEEDBACK} = 1.3\text{V}$ ADJ Version Only	85			nA
$V_{S/D}$	ON/OFF Pin Voltage Thesholds		1.4	0.8	2.0	V
$I_{S/D}$	ON/OFF Pin Current	ON/OFF Pin = 0V	20	7	37	μA
θ_{JA}	Thermal Resistance	N Package, Junction to Ambient (Note 6)	95			$^\circ\text{C/W}$
		M Package, Junction to Ambient (Note 6)	105			

Note 1: Absolute Maximum Ratings indicate limits beyond which damage to the device may occur. Operating Ratings indicate conditions for which the device is intended to be functional, but device parameter specifications may not be guaranteed under these conditions. For guaranteed specifications and test conditions, see the Electrical Characteristics.

Note 2: The human body model is a 100 pF capacitor discharged through a 1.5 k Ω resistor into each pin.

Note 3: External components such as the catch diode, inductor, input and output capacitors, and voltage programming resistors can affect switching regulator performance. When the LM2674 is used as shown in Figures 2, 3 test circuits, system performance will be as specified by the system parameters section of the Electrical Characteristics.

Note 4: Typical numbers are at 25 $^\circ\text{C}$ and represent the most likely norm.

Note 5: All limits guaranteed at room temperature (standard type face) and at **temperature extremes (bold type face)**. All room temperature limits are 100% production tested. All limits at **temperature extremes** are guaranteed via correlation using standard Statistical Quality Control (SQC) methods. All limits are used to calculate Average Outgoing Quality Level (AOQL).

Note 6: Junction to ambient thermal resistance with approximately 1 square inch of printed circuit board copper surrounding the leads. Additional copper area will lower thermal resistance further. See Application Information section in the application note accompanying this datasheet and the thermal model in **LM267X Made Simple** software.

Connection Diagram and Ordering Information

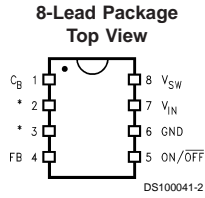

* No Connections

**For Surface Mount Package
Order Number
LM2674M-3.3, LM2674M-5.0,
LM2674M-12 or LM2674M-ADJ
See NSC Package Number M08A**

**For DIP Package
Order Number
LM2674N-3.3, LM2674N-5.0,
LM2674N-12 or LM2674N-ADJ
See NSC Package Number N08E**

Typical Performance Characteristics

**Normalized
Output Voltage**

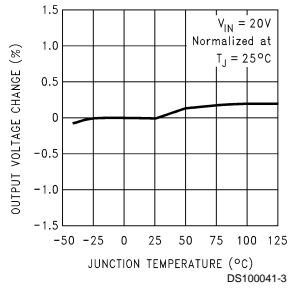

Line Regulation

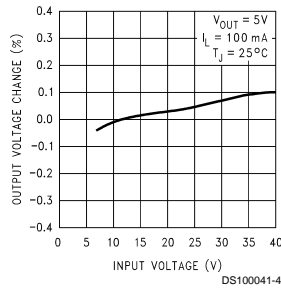

Efficiency

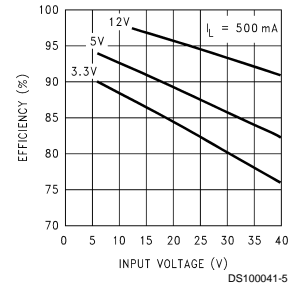

**Drain-to-Source
Resistance**

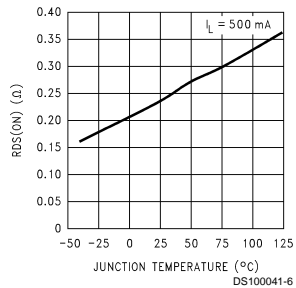

Switch Current Limit

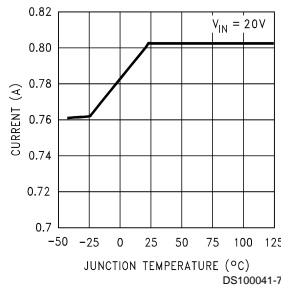

**Operating
Quiescent Current**

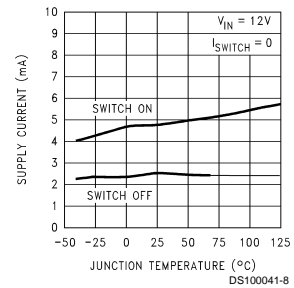

Typical Performance Characteristics (Continued)

Standby Quiescent Current

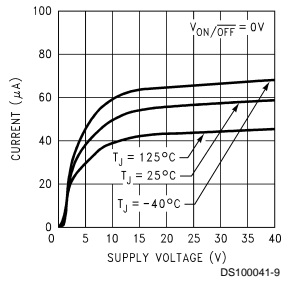

ON/OFF Threshold Voltage

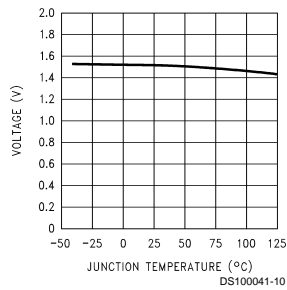

ON/OFF Pin Current (Sourcing)

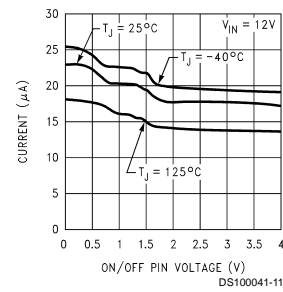

Switching Frequency

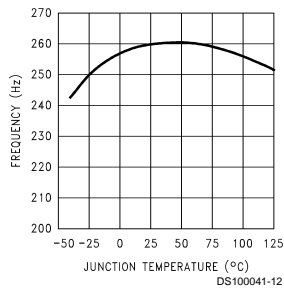

Feedback Pin Bias Current

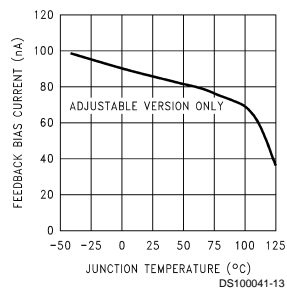

Peak Switch Current

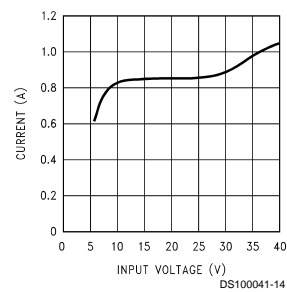

Dropout Voltage— 3.3V Option

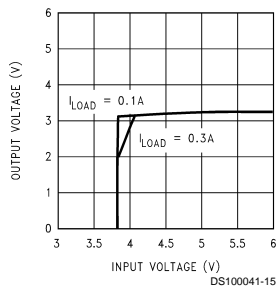

Dropout Voltage— 5.0V Option

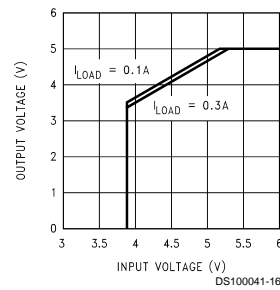

Block Diagram

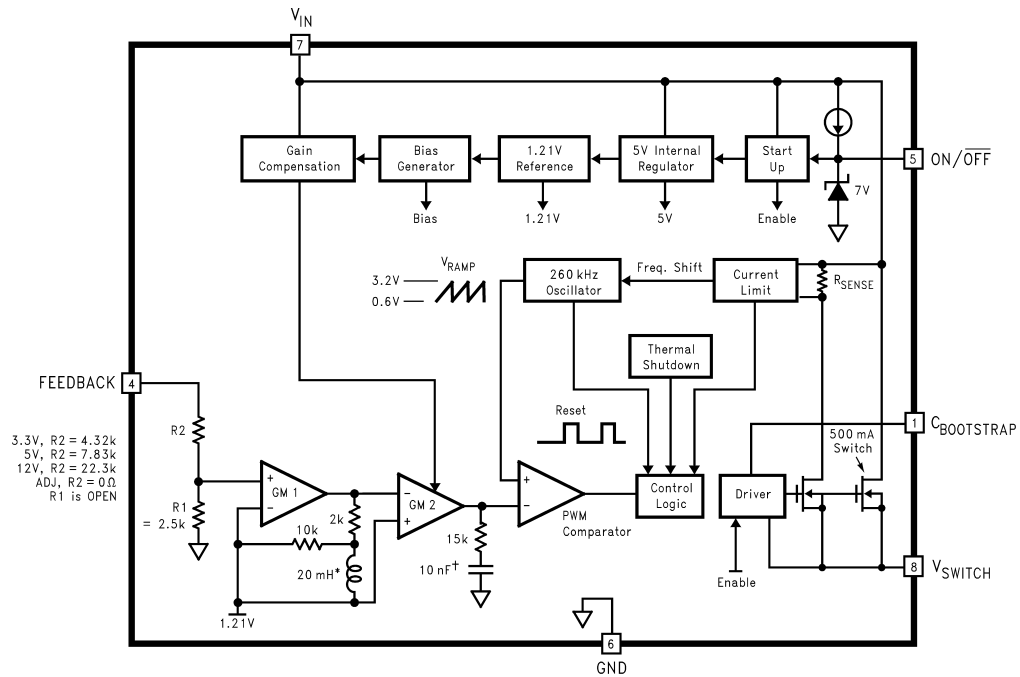

* Active Inductor Patent Number 5,514,947

† Active Capacitor Patent Number 5,382,918

FIGURE 1.

Typical Performance Characteristics (Circuit of Figure 2)

Continuous Mode Switching Waveforms

$V_{IN} = 20V$, $V_{OUT} = 5V$, $I_{LOAD} = 500\text{ mA}$
 $L = 100\ \mu\text{H}$, $C_{OUT} = 100\ \mu\text{F}$, $C_{OUTESR} = 0.1\ \Omega$

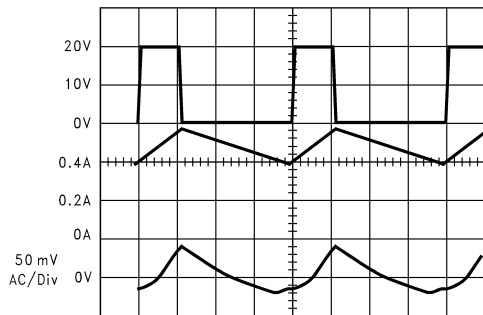

A: V_{SW} Pin Voltage, 10 V/div.

B: Inductor Current, 0.2 A/div

C: Output Ripple Voltage, 50 mV/div AC-Coupled

Horizontal Time Base: 1 $\mu\text{s}/\text{div}$

Discontinuous Mode Switching Waveforms

$V_{IN} = 20V$, $V_{OUT} = 5V$, $I_{LOAD} = 300\text{ mA}$
 $L = 15\ \mu\text{H}$, $C_{OUT} = 68\ \mu\text{F}$ (2x), $C_{OUTESR} = 25\ \text{m}\Omega$

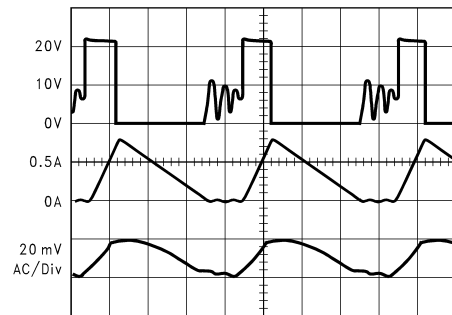

A: V_{SW} Pin Voltage, 10 V/div.

B: Inductor Current, 0.5 A/div

C: Output Ripple Voltage, 20 mV/div AC-Coupled

Horizontal Time Base: 1 $\mu\text{s}/\text{div}$

Typical Performance Characteristics (Circuit of Figure 2) (Continued)

Load Transient Response for Continuous Mode

$V_{IN} = 20V, V_{OUT} = 5V,$
 $L = 100 \mu H, C_{OUT} = 100 \mu F, C_{OUTESR} = 0.1 \Omega$

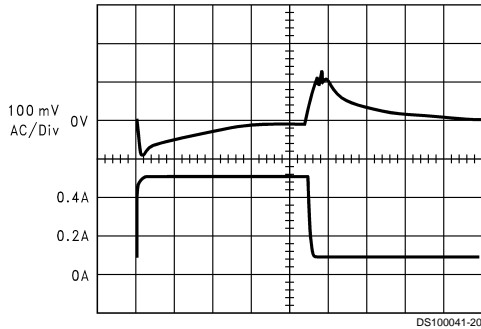

A: Output Voltage, 100 mV/div, AC-Coupled.
 B: Load Current: 100 mA to 500 mA Load Pulse

Horizontal Time Base: 50 μs /div

Load Transient Response for Discontinuous Mode

$V_{IN} = 20V, V_{OUT} = 5V,$
 $L = 47 \mu H, C_{OUT} = 68 \mu F, C_{OUTESR} = 50 m\Omega$

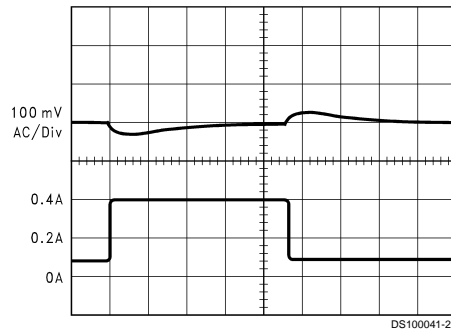

A: Output Voltage, 100 mV/div, AC-Coupled.
 B: Load Current: 100 mA to 400 mA Load Pulse

Horizontal Time Base: 200 μs /div

Test Circuit and Layout Guidelines

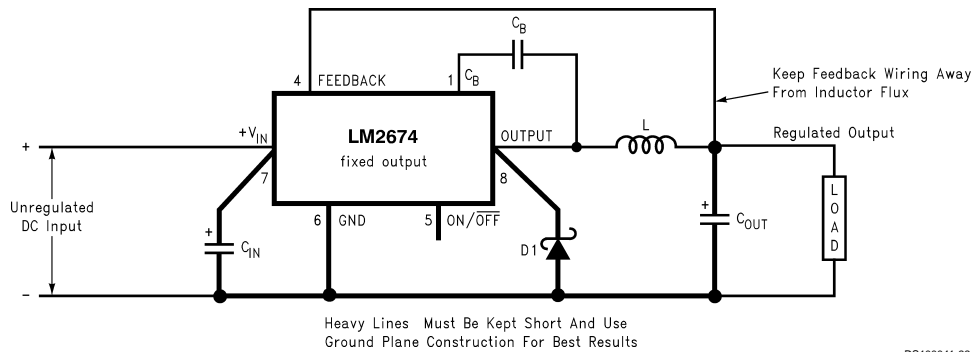

C_{IN} - 22 μF , 50V Tantalum, Sprague "199D Series"
 C_{OUT} - 47 μF , 25V Tantalum, Sprague "595D Series"
 D1 - 3.3A, 50V Schottky Rectifier, IR 30WQ05F
 L1 - 68 μH Sumida #RCR110D-680L
 C_B - 0.01 μF , 50V Ceramic

FIGURE 2. Standard Test Circuits and Layout Guides
 Fixed Output Voltage Versions

Test Circuit and Layout Guidelines (Continued)

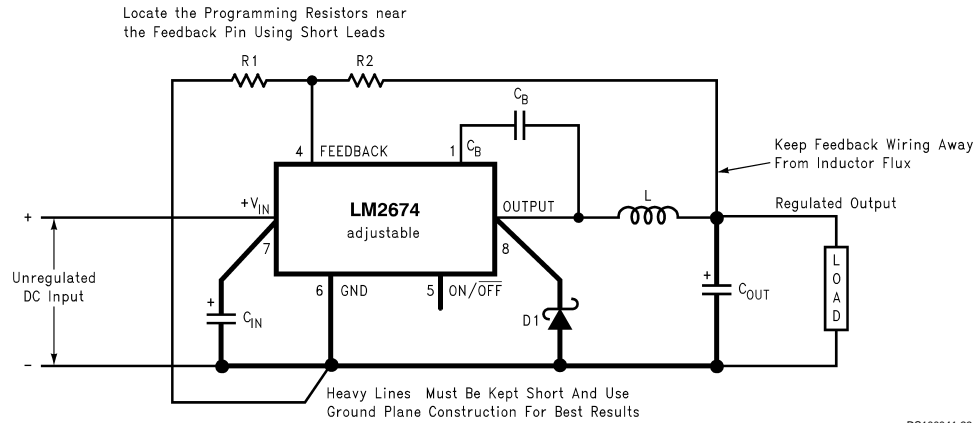

DS100041-23

C_{IN} - 22 μ F, 50V Tantalum, Sprague "199D Series"
 C_{OUT} - 47 μ F, 25V Tantalum, Sprague "595D Series"
 D1 - 3.3A, 50V Schottky Rectifier, IR 30WQ05F
 L1 - 68 μ H Sumida #RCR110D-680L
 R1 - 1.5 k Ω , 1%
 C_B - 0.01 μ F, 50V Ceramic
 For a 5V output, select R2 to be 4.75 k Ω , 1%

$$V_{OUT} = V_{REF} \left(1 + \frac{R_2}{R_1} \right)$$

where $V_{REF} = 1.21V$

$$R_2 = R_1 \left(\frac{V_{OUT}}{V_{REF}} - 1 \right)$$

Use a 1% resistor for best stability.

**FIGURE 3. Standard Test Circuits and Layout Guides
Adjustable Output Voltage Versions**

LM2674 Series Buck Regulator Design Procedure (Fixed Output)

PROCEDURE (Fixed Output Voltage Version)

To simplify the buck regulator design procedure, National Semiconductor is making available computer design software to be used with the SIMPLE SWITCHER line of switching regulators. **LM267X Made Simple** is available on Windows® 3.1, NT, or 95 operating systems.

Given:

V_{OUT} = Regulated Output Voltage (3.3V, 5V, or 12V)

$V_{IN(max)}$ = Maximum DC Input Voltage

$I_{LOAD(max)}$ = Maximum Load Current

1. Inductor Selection (L1)

A. Select the correct inductor value selection guide from *Figure 4*, *Figure 5* or *Figure 6* (output voltages of 3.3V, 5V, or 12V respectively). For all other voltages, see the design procedure for the adjustable version.

B. From the inductor value selection guide, identify the inductance region intersected by the Maximum Input Voltage line and the Maximum Load Current line. Each region is identified by an inductance value and an inductor code (LXX).

EXAMPLE (Fixed Output Voltage Version)

Given:

$V_{OUT} = 5V$

$V_{IN(max)} = 12V$

$I_{LOAD(max)} = 500 \text{ mA}$

1. Inductor Selection (L1)

A. Use the inductor selection guide for the 5V version shown in *Figure 5*.

B. From the inductor value selection guide shown in *Figure 5*, the inductance region intersected by the 12V horizontal line and the 500mA vertical line is 47 μ H, and the inductor code is L13.

LM2674 Series Buck Regulator Design Procedure (Fixed Output) (Continued)

PROCEDURE (Fixed Output Voltage Version)	EXAMPLE (Fixed Output Voltage Version)
<p>C. Select an appropriate inductor from the four manufacturer's part numbers listed in <i>Figure 8</i>. Each manufacturer makes a different style of inductor to allow flexibility in meeting various design requirements. Listed below are some of the differentiating characteristics of each manufacturer's inductors:</p> <p><i>Schott</i>: ferrite EP core inductors; these have very low leakage magnetic fields to reduce electro-magnetic interference (EMI) and are the lowest power loss inductors</p> <p><i>Renco</i>: ferrite stick core inductors; benefits are typically lowest cost inductors and can withstand E•T and transient peak currents above rated value. Be aware that these inductors have an external magnetic field which may generate more EMI than other types of inductors.</p> <p><i>Pulse</i>: powdered iron toroid core inductors; these can also be low cost and can withstand larger than normal E•T and transient peak currents. Toroid inductors have low EMI.</p> <p><i>Coilcraft</i>: ferrite drum core inductors; these are the smallest physical size inductors, available only as SMT components. Be aware that these inductors also generate EMI—but less than stick inductors.</p> <p>Complete specifications for these inductors are available from the respective manufacturers. A table listing the manufacturers' phone numbers is located in <i>Figure 9</i>.</p> <p>2. Output Capacitor Selection (C_{OUT})</p> <p>A. Select an output capacitor from the output capacitor table in <i>Figure 10</i>. Using the output voltage and the inductance value found in the inductor selection guide, step 1, locate the appropriate capacitor value and voltage rating.</p> <p>The capacitor list contains through-hole electrolytic capacitors from four different capacitor manufacturers and surface mount tantalum capacitors from two different capacitor manufacturers. It is recommended that both the manufacturers and the manufacturer's series that are listed in the table be used. A table listing the manufacturers' phone numbers is located in <i>Figure 11</i>.</p> <p>3. Catch Diode Selection (D1)</p> <p>A. In normal operation, the average current of the catch diode is the load current times the catch diode duty cycle, 1-D (D is the switch duty cycle, which is approximately the output voltage divided by the input voltage). The largest value of the catch diode average current occurs at the maximum load current and maximum input voltage (minimum D). For normal operation, the catch diode current rating must be at least 1.3 times greater than its maximum average current. However, if the power supply design must withstand a continuous output short, the diode should have a current rating equal to the maximum current limit of the LM2674. The most stressful condition for this diode is a shorted output condition.</p> <p>B. The reverse voltage rating of the diode should be at least 1.25 times the maximum input voltage.</p> <p>C. Because of their fast switching speed and low forward voltage drop, Schottky diodes provide the best performance and efficiency. This Schottky diode must be located close to the LM2674 using short leads and short printed circuit traces.</p>	<p>C. The inductance value required is 47 μH. From the table in <i>Figure 8</i>, go to the L13 line and choose an inductor part number from any of the four manufacturers shown. (In most instances, both through hole and surface mount inductors are available.)</p> <p>2. Output Capacitor Selection (C_{OUT})</p> <p>A. Use the 5.0V section in the output capacitor table in <i>Figure 10</i>. Choose a capacitor value and voltage rating from the line that contains the inductance value of 47 μH. The capacitance and voltage rating values corresponding to the 47 μH inductor are the:</p> <p>Surface Mount: 68 μF/10V Sprague 594D Series. 100 μF/10V AVX TPS Series.</p> <p>Through Hole: 68 μF/10V Sanyo OS-CON SA Series. 150 μF/35V Sanyo MV-GX Series. 150 μF/35V Nichicon PL Series. 150 μF/35V Panasonic HFQ Series.</p> <p>3. Catch Diode Selection (D1)</p> <p>A. Refer to the table shown in <i>Figure 12</i>. In this example, a 1A, 20V Schottky diode will provide the best performance. If the circuit must withstand a continuous shorted output, a higher current Schottky diode is recommended.</p>

LM2674 Series Buck Regulator Design Procedure (Fixed Output) (Continued)

PROCEDURE (Fixed Output Voltage Version)	EXAMPLE (Fixed Output Voltage Version)
<p>4. Input Capacitor (C_{IN})</p> <p>A low ESR aluminum or tantalum bypass capacitor is needed between the input pin and ground to prevent large voltage transients from appearing at the input. This capacitor should be located close to the IC using short leads. In addition, the RMS current rating of the input capacitor should be selected to be at least $\frac{1}{2}$ the DC load current. The capacitor manufacturer data sheet must be checked to assure that this current rating is not exceeded. The curves shown in <i>Figure 14</i> show typical RMS current ratings for several different aluminum electrolytic capacitor values. A parallel connection of two or more capacitors may be required to increase the total minimum RMS current rating to suit the application requirements.</p> <p>For an aluminum electrolytic capacitor, the voltage rating should be at least 1.25 times the maximum input voltage. Caution must be exercised if solid tantalum capacitors are used. The tantalum capacitor voltage rating should be twice the maximum input voltage. The tables in <i>Figure 15</i> show the recommended application voltage for AVX TPS and Sprague 594D tantalum capacitors. It is also recommended that they be surge current tested by the manufacturer. The TPS series available from AVX, and the 593D and 594D series from Sprague are all surge current tested. Another approach to minimize the surge current stresses on the input capacitor is to add a small inductor in series with the input supply line. Use caution when using ceramic capacitors for input bypassing, because it may cause severe ringing at the V_{IN} pin.</p> <p>5. Boost Capacitor (C_B)</p> <p>This capacitor develops the necessary voltage to turn the switch gate on fully. All applications should use a 0.01 μF, 50V ceramic capacitor.</p>	<p>4. Input Capacitor (C_{IN})</p> <p>The important parameters for the input capacitor are the input voltage rating and the RMS current rating. With a maximum input voltage of 12V, an aluminum electrolytic capacitor with a voltage rating greater than 15V ($1.25 \times V_{IN}$) would be needed. The next higher capacitor voltage rating is 16V.</p> <p>The RMS current rating requirement for the input capacitor in a buck regulator is approximately $\frac{1}{2}$ the DC load current. In this example, with a 500mA load, a capacitor with an RMS current rating of at least 250 mA is needed. The curves shown in <i>Figure 14</i> can be used to select an appropriate input capacitor. From the curves, locate the 16V line and note which capacitor values have RMS current ratings greater than 250 mA.</p> <p>For a through hole design, a 100 μF/16V electrolytic capacitor (Panasonic HFQ series, Nichicon PL, Sanyo MV-GX series or equivalent) would be adequate. Other types or other manufacturers' capacitors can be used provided the RMS ripple current ratings are adequate. Additionally, for a complete surface mount design, electrolytic capacitors such as the Sanyo CV-C or CV-BS and the Nichicon WF or UR and the NIC Components NACZ series could be considered.</p> <p>For surface mount designs, solid tantalum capacitors can be used, but caution must be exercised with regard to the capacitor surge current rating and voltage rating. In this example, checking <i>Figure 15</i>, and the Sprague 594D series datasheet, a Sprague 594D 15 μF, 25V capacitor is adequate.</p> <p>5. Boost Capacitor (C_B)</p> <p>For this application, and all applications, use a 0.01 μF, 50V ceramic capacitor.</p>

LM2674 Series Buck Regulator Design Procedure (Fixed Output) (Continued)

INDUCTOR VALUE SELECTION GUIDES (For Continuous Mode Operation)

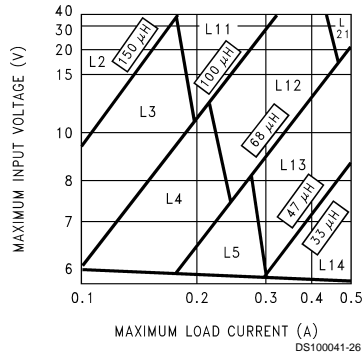

FIGURE 4. LM2674-3.3

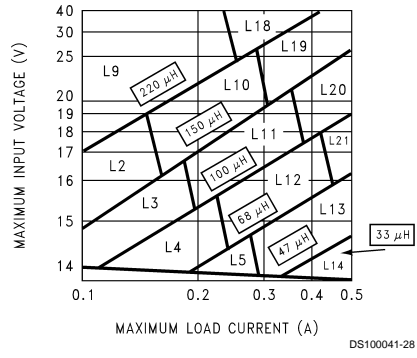

FIGURE 6. LM2674-12

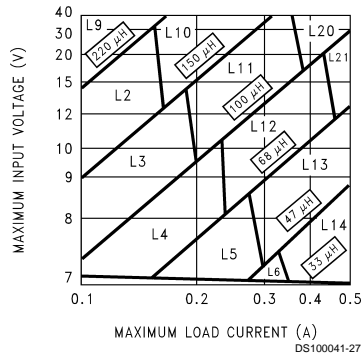

FIGURE 5. LM2674-5.0

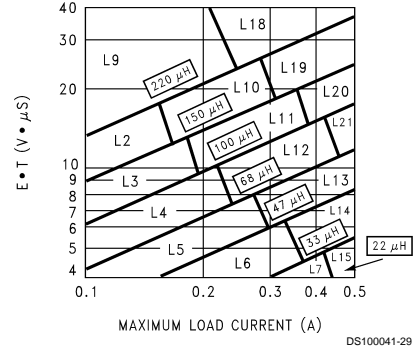

FIGURE 7. LM2674-ADJ

LM2674 Series Buck Regulator Design Procedure (Fixed Output) (Continued)

Ind. Ref. Desg.	Inductance (µH)	Current (A)	Schott		Renco		Pulse Engineering		Coilcraft
			Through Hole	Surface Mount	Through Hole	Surface Mount	Through Hole	Surface Mount	Surface Mount
L2	150	0.21	67143920	67144290	RL-5470-4	RL1500-150	PE-53802	PE-53802-S	DO1608-154
L3	100	0.26	67143930	67144300	RL-5470-5	RL1500-100	PE-53803	PE-53803-S	DO1608-104
L4	68	0.32	67143940	67144310	RL-1284-68-43	RL1500-68	PE-53804	PE-53804-S	DO1608-683
L5	47	0.37	67148310	67148420	RL-1284-47-43	RL1500-47	PE-53805	PE-53805-S	DO1608-473
L6	33	0.44	67148320	67148430	RL-1284-33-43	RL1500-33	PE-53806	PE-53806-S	DO1608-333
L7	22	0.52	67148330	67148440	RL-1284-22-43	RL1500-22	PE-53807	PE-53807-S	DO1608-223
L9	220	0.32	67143960	67144330	RL-5470-3	RL1500-220	PE-53809	PE-53809-S	DO3308-224
L10	150	0.39	67143970	67144340	RL-5470-4	RL1500-150	PE-53810	PE-53810-S	DO3308-154
L11	100	0.48	67143980	67144350	RL-5470-5	RL1500-100	PE-53811	PE-53811-S	DO3308-104
L12	68	0.58	67143990	67144360	RL-5470-6	RL1500-68	PE-53812	PE-53812-S	DO3308-683
L13	47	0.70	67144000	67144380	RL-5470-7	RL1500-47	PE-53813	PE-53813-S	DO3308-473
L14	33	0.83	67148340	67148450	RL-1284-33-43	RL1500-33	PE-53814	PE-53814-S	DO3308-333
L15	22	0.99	67148350	67148460	RL-1284-22-43	RL1500-22	PE-53815	PE-53815-S	DO3308-223
L18	220	0.55	67144040	67144420	RL-5471-2	RL1500-220	PE-53818	PE-53818-S	DO3316-224
L19	150	0.66	67144050	67144430	RL-5471-3	RL1500-150	PE-53819	PE-53819-S	DO3316-154
L20	100	0.82	67144060	67144440	RL-5471-4	RL1500-100	PE-53820	PE-53820-S	DO3316-104
L21	68	0.99	67144070	67144450	RL-5471-5	RL1500-68	PE-53821	PE-53821-S	DO3316-683

FIGURE 8. Inductor Manufacturers' Part Numbers

Coilcraft Inc.	Phone	(800) 322-2645
	FAX	(708) 639-1469
Coilcraft Inc., Europe	Phone	+44 1236 730 595
	FAX	+44 1236 730 627
Pulse Engineering Inc.	Phone	(619) 674-8100
	FAX	(619) 674-8262
Pulse Engineering Inc., Europe	Phone	+353 93 24 107
	FAX	+353 93 24 459
Renco Electronics Inc.	Phone	(800) 645-5828
	FAX	(516) 586-5562
Schott Corp.	Phone	(612) 475-1173
	FAX	(612) 475-1786

FIGURE 9. Inductor Manufacturers' Phone Numbers

LM2674 Series Buck Regulator Design Procedure (Fixed Output) (Continued)

Output Voltage (V)	Inductance (μ H)	Output Capacitor					
		Surface Mount		Through Hole			
		Sprague 594D Series (μ F/V)	AVX TPS Series (μ F/V)	Sanyo OS-CON SA Series (μ F/V)	Sanyo MV-GX Series (μ F/V)	Nichicon PL Series (μ F/V)	Panasonic HFQ Series (μ F/V)
3.3	22	120/6.3	100/10	100/10	330/35	330/35	330/35
	33	120/6.3	100/10	68/10	220/35	220/35	220/35
	47	68/10	100/10	68/10	150/35	150/35	150/35
	68	120/6.3	100/10	100/10	120/35	120/35	120/35
	100	120/6.3	100/10	100/10	120/35	120/35	120/35
	150	120/6.3	100/10	100/10	120/35	120/35	120/35
5.0	22	100/16	100/10	100/10	330/35	330/35	330/35
	33	68/10	100/10	68/10	220/35	220/35	220/35
	47	68/10	100/10	68/10	150/35	150/35	150/35
	68	100/16	100/10	100/10	120/35	120/35	120/35
	100	100/16	100/10	100/10	120/35	120/35	120/35
	150	100/16	100/10	100/10	120/35	120/35	120/35
12	22	120/20	(2x) 68/20	68/20	330/35	330/35	330/35
	33	68/25	68/20	68/20	220/35	220/35	220/35
	47	47/20	68/20	47/20	150/35	150/35	150/35
	68	47/20	68/20	47/20	120/35	120/35	120/35
	100	47/20	68/20	47/20	120/35	120/35	120/35
	150	47/20	68/20	47/20	120/35	120/35	120/35
	220	47/20	68/20	47/20	120/35	120/35	120/35

FIGURE 10. Output Capacitor Table

Nichicon Corp.	Phone	(847) 843-7500
	FAX	(847) 843-2798
Panasonic	Phone	(714) 373-7857
	FAX	(714) 373-7102
AVX Corp.	Phone	(845) 448-9411
	FAX	(845) 448-1943
Sprague/Vishay	Phone	(207) 324-4140
	FAX	(207) 324-7223
Sanyo Corp.	Phone	(619) 661-6322
	FAX	(619) 661-1055

FIGURE 11. Capacitor Manufacturers' Phone Numbers

LM2674 Series Buck Regulator Design Procedure (Fixed Output) (Continued)

V _R	500mA Diodes		3A Diodes	
	Surface Mount	Through Hole	Surface Mount	Through Hole
20V	SK12	1N5817	SK32	1N5820
	B120	SR102		SR302
30V	SK13	1N5818	SK33	1N5821
	B130	11DQ03	30WQ03F	31DQ03
	MBRS130	SR103		
40V	SK14	1N5819	SK34	1N5822
	B140	11DQ04	30BQ040	MBR340
	MBRS140	SR104	30WQ04F	31DQ04
	10BQ040		MBRS340	SR304
	10MQ040		MBRD340	
	15MQ040			
50V	SK15	MBR150	SK35	MBR350
	B150	11DQ05	30WQ05F	31DQ05
	10BQ050	SR105		SR305

FIGURE 12. Schottky Diode Selection Table

International Rectifier Corp.	Phone	(310) 322-3331
	FAX	(310) 322-3332
Motorola, Inc.	Phone	(800) 521-6274
	FAX	(602) 244-6609
General Instruments Corp.	Phone	(516) 847-3000
	FAX	(516) 847-3236
Diodes, Inc.	Phone	(805) 446-4800
	FAX	(805) 446-4850

FIGURE 13. Diode Manufacturers' Phone Numbers

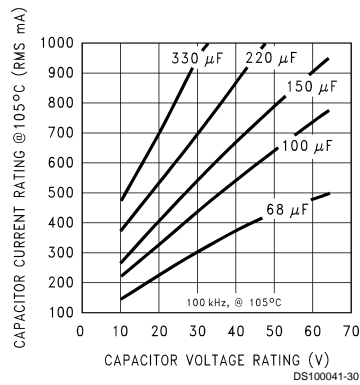

FIGURE 14. RMS Current Ratings for Low ESR Electrolytic Capacitors (Typical)

LM2674 Series Buck Regulator Design Procedure (Fixed Output) (Continued)

AVX TPS

Recommended Application Voltage	Voltage Rating
+85°C Rating	
3.3	6.3
5	10
10	20
12	25
15	35

Sprague 594D

Recommended Application Voltage	Voltage Rating
+85°C Rating	
2.5	4
3.3	6.3
5	10
8	16
12	20
18	25
24	35
29	50

FIGURE 15. Recommended Application Voltage for AVX TPS and Sprague 594D Tantalum Chip Capacitors Derated for 85°C.

LM2674 Series Buck Regulator Design Procedure (Adjustable Output)

PROCEDURE (Adjustable Output Voltage Version)	EXAMPLE (Adjustable Output Voltage Version)
<p>To simplify the buck regulator design procedure, National Semiconductor is making available computer design software to be used with the SIMPLE SWITCHER line of switching regulators. LM267X Made Simple is available for use on Windows 3.1, NT, or 95 operating systems.</p> <p>Given:</p> <p>V_{OUT} = Regulated Output Voltage $V_{IN(max)}$ = Maximum Input Voltage $I_{LOAD(max)}$ = Maximum Load Current F = Switching Frequency (Fixed at a nominal 260 kHz).</p> <p>1. Programming Output Voltage (Selecting R_1 and R_2, as shown in Figure 3)</p> <p>Use the following formula to select the appropriate resistor values.</p> $V_{OUT} = V_{REF} \left(1 + \frac{R_2}{R_1} \right)$ <p>where $V_{REF} = 1.21V$</p> <p>Select a value for R_1 between 240Ω and 1.5 kΩ. The lower resistor values minimize noise pickup in the sensitive feedback pin. (For the lowest temperature coefficient and the best stability with time, use 1% metal film resistors.)</p> $R_2 = R_1 \left(\frac{V_{OUT}}{V_{REF}} - 1 \right)$	<p>Given:</p> <p>$V_{OUT} = 20V$ $V_{IN(max)} = 28V$ $I_{LOAD(max)} = 500 \text{ mA}$ F = Switching Frequency (Fixed at a nominal 260 kHz).</p> <p>1. Programming Output Voltage (Selecting R_1 and R_2, as shown in Figure 3)</p> <p>Select R_1 to be 1 kΩ, 1%. Solve for R_2.</p> $R_2 = R_1 \left(\frac{V_{OUT}}{V_{REF}} - 1 \right) = 1 \text{ k}\Omega \left(\frac{20V}{1.23V} - 1 \right)$ <p>$R_2 = 1k (16.53 - 1) = 15.53 \text{ k}\Omega$, closest 1% value is 15.4 kΩ. $R_2 = 15.4 \text{ k}\Omega$.</p>

LM2674 Series Buck Regulator Design Procedure (Adjustable Output)

(Continued)

PROCEDURE (Adjustable Output Voltage Version)	EXAMPLE (Adjustable Output Voltage Version)
<p>2. Inductor Selection (L1)</p> <p>A. Calculate the inductor Volt • microsecond constant $E \cdot T$ ($V \cdot \mu s$), from the following formula:</p> $E \cdot T = (V_{IN(MAX)} - V_{OUT} - V_{SAT}) \cdot \frac{V_{OUT} + V_D}{V_{IN(MAX)} - V_{SAT} + V_D} \cdot \frac{1000}{260} (V \cdot \mu s)$ <p>where V_{SAT}=internal switch saturation voltage=0.25V and V_D = diode forward voltage drop = 0.5V</p> <p>B. Use the $E \cdot T$ value from the previous formula and match it with the $E \cdot T$ number on the vertical axis of the Inductor Value Selection Guide shown in <i>Figure 7</i>.</p> <p>C. On the horizontal axis, select the maximum load current.</p> <p>D. Identify the inductance region intersected by the $E \cdot T$ value and the Maximum Load Current value. Each region is identified by an inductance value and an inductor code (LXX).</p> <p>E. Select an appropriate inductor from the four manufacturer's part numbers listed in <i>Figure 8</i>. For information on the different types of inductors, see the inductor selection in the fixed output voltage design procedure.</p> <p>3. Output Capacitor Selection (C_{OUT})</p> <p>A. Select an output capacitor from the capacitor code selection guide in <i>Figure 16</i>. Using the inductance value found in the inductor selection guide, step 1, locate the appropriate capacitor code corresponding to the desired output voltage.</p> <p>B. Select an appropriate capacitor value and voltage rating, using the capacitor code, from the output capacitor selection table in <i>Figure 17</i>. There are two solid tantalum (surface mount) capacitor manufacturers and four electrolytic (through hole) capacitor manufacturers to choose from. It is recommended that both the manufacturers and the manufacturer's series that are listed in the table be used. A table listing the manufacturers' phone numbers is located in <i>Figure 11</i>.</p>	<p>2. Inductor Selection (L1)</p> <p>A. Calculate the inductor Volt • microsecond constant ($E \cdot T$),</p> $E \cdot T = (28 - 20 - 0.25) \cdot \frac{20 + 0.5}{28 - 0.25 + 0.5} \cdot \frac{1000}{260} (V \cdot \mu s)$ $E \cdot T = (7.75) \cdot \frac{20.5}{28.25} \cdot 3.85 (V \cdot \mu s) = 21.6 (V \cdot \mu s)$ <p>B. $E \cdot T = 21.6 (V \cdot \mu s)$</p> <p>C. $I_{LOAD(max)} = 500 \text{ mA}$</p> <p>D. From the inductor value selection guide shown in <i>Figure 7</i>, the inductance region intersected by the 21.6 ($V \cdot \mu s$) horizontal line and the 500mA vertical line is 100 μH, and the inductor code is L20.</p> <p>E. From the table in <i>Figure 8</i>, locate line L20, and select an inductor part number from the list of manufacturers part numbers.</p> <p>3. Output Capacitor Selection (C_{OUT})</p> <p>A. Use the appropriate row of the capacitor code selection guide, in <i>Figure 16</i>. For this example, use the 15–20V row. The capacitor code corresponding to an inductance of 100 μH is C20.</p> <p>B. From the output capacitor selection table in <i>Figure 17</i>, choose a capacitor value (and voltage rating) that intersects the capacitor code(s) selected in section A, C20. The capacitance and voltage rating values corresponding to the capacitor code C20 are the:</p> <p>Surface Mount:</p> <p>33 $\mu F/25V$ Sprague 594D Series. 33 $\mu F/25V$ AVX TPS Series.</p> <p>Through Hole:</p> <p>33 $\mu F/25V$ Sanyo OS-CON SC Series. 120 $\mu F/35V$ Sanyo MV-GX Series. 120 $\mu F/35V$ Nichicon PL Series. 120 $\mu F/35V$ Panasonic HFQ Series.</p> <p>Other manufacturers or other types of capacitors may also be used, provided the capacitor specifications (especially the 100 kHz ESR) closely match the characteristics of the capacitors listed in the output capacitor table. Refer to the capacitor manufacturers' data sheet for this information.</p>

LM2674 Series Buck Regulator Design Procedure (Adjustable Output)

(Continued)

PROCEDURE (Adjustable Output Voltage Version)	EXAMPLE (Adjustable Output Voltage Version)
<p>4. Catch Diode Selection (D1)</p> <p>A. In normal operation, the average current of the catch diode is the load current times the catch diode duty cycle, 1-D (D is the switch duty cycle, which is approximately V_{OUT}/V_{IN}). The largest value of the catch diode average current occurs at the maximum input voltage (minimum D). For normal operation, the catch diode current rating must be at least 1.3 times greater than its maximum average current. However, if the power supply design must withstand a continuous output short, the diode should have a current rating greater than the maximum current limit of the LM2674. The most stressful condition for this diode is a shorted output condition.</p> <p>B. The reverse voltage rating of the diode should be at least 1.25 times the maximum input voltage.</p> <p>C. Because of their fast switching speed and low forward voltage drop, Schottky diodes provide the best performance and efficiency. The Schottky diode must be located close to the LM2674 using short leads and short printed circuit traces.</p> <p>5. Input Capacitor (C_{IN})</p> <p>A low ESR aluminum or tantalum bypass capacitor is needed between the input pin and ground to prevent large voltage transients from appearing at the input. This capacitor should be located close to the IC using short leads. In addition, the RMS current rating of the input capacitor should be selected to be at least ½ the DC load current. The capacitor manufacturer data sheet must be checked to assure that this current rating is not exceeded. The curves shown in <i>Figure 14</i> show typical RMS current ratings for several different aluminum electrolytic capacitor values. A parallel connection of two or more capacitors may be required to increase the total minimum RMS current rating to suit the application requirements.</p> <p>For an aluminum electrolytic capacitor, the voltage rating should be at least 1.25 times the maximum input voltage. Caution must be exercised if solid tantalum capacitors are used. The tantalum capacitor voltage rating should be twice the maximum input voltage. The tables in <i>Figure 15</i> show the recommended application voltage for AVX TPS and Sprague 594D tantalum capacitors. It is also recommended that they be surge current tested by the manufacturer. The TPS series available from AVX, and the 593D and 594D series from Sprague are all surge current tested. Another approach to minimize the surge current stresses on the input capacitor is to add a small inductor in series with the input supply line. Use caution when using ceramic capacitors for input bypassing, because it may cause severe ringing at the V_{IN} pin.</p> <p>6. Boost Capacitor (C_B)</p> <p>This capacitor develops the necessary voltage to turn the switch gate on fully. All applications should use a 0.01 μF, 50V ceramic capacitor.</p>	<p>4. Catch Diode Selection (D1)</p> <p>A. Refer to the table shown in <i>Figure 12</i>. Schottky diodes provide the best performance, and in this example a 500mA, 40V Schottky diode would be a good choice. If the circuit must withstand a continuous shorted output, a higher current (at least 1.2A) Schottky diode is recommended.</p> <p>5. Input Capacitor (C_{IN})</p> <p>The important parameters for the input capacitor are the input voltage rating and the RMS current rating. With a maximum input voltage of 28V, an aluminum electrolytic capacitor with a voltage rating of at least 35V (1.25 x V_{IN}) would be needed. The RMS current rating requirement for the input capacitor in a buck regulator is approximately ½ the DC load current. In this example, with a 500mA load, a capacitor with an RMS current rating of at least 250 mA is needed. The curves shown in <i>Figure 14</i> can be used to select an appropriate input capacitor. From the curves, locate the 35V line and note which capacitor values have RMS current ratings greater than 250 mA. For a through hole design, a 68 μF/35V electrolytic capacitor (Panasonic HFQ series, Nichicon PL, Sanyo MV-GX series or equivalent) would be adequate. Other types or other manufacturers' capacitors can be used provided the RMS ripple current ratings are adequate. Additionally, for a complete surface mount design, electrolytic capacitors such as the Sanyo CV-C or CV-BS, and the Nichicon WF or UR and the NIC Components NACZ series could be considered. For surface mount designs, solid tantalum capacitors can be used, but caution must be exercised with regard to the capacitor surge current rating and voltage rating. In this example, checking <i>Figure 15</i>, and the Sprague 594D series datasheet, a Sprague 594D 15 μF, 50V capacitor is adequate.</p> <p>6. Boost Capacitor (C_B)</p> <p>For this application, and all applications, use a 0.01 μF, 50V ceramic capacitor.</p>

LM2674 Series Buck Regulator Design Procedure (Adjustable Output)

(Continued)

Case Style (Note 7)	Output Voltage (V)	Inductance (μH)						
		22	33	47	68	100	150	220
SM and TH	1.21–2.50	—	—	—	—	C1	C2	C3
SM and TH	2.50–3.75	—	—	—	C1	C2	C3	C3
SM and TH	3.75–5.0	—	—	C4	C5	C6	C6	C6
SM and TH	5.0–6.25	—	C4	C7	C6	C6	C6	C6
SM and TH	6.25–7.5	C8	C4	C7	C6	C6	C6	C6
SM and TH	7.5–10.0	C9	C10	C11	C12	C13	C13	C13
SM and TH	10.0–12.5	C14	C11	C12	C12	C13	C13	C13
SM and TH	12.5–15.0	C15	C16	C17	C17	C17	C17	C17
SM and TH	15.0–20.0	C18	C19	C20	C20	C20	C20	C20
SM and TH	20.0–30.0	C21	C22	C22	C22	C22	C22	C22
TH	30.0–37.0	C23	C24	C24	C25	C25	C25	C25

Note 7: SM - Surface Mount, TH - Through Hole

FIGURE 16. Capacitor Code Selection Guide

LM2674 Series Buck Regulator Design Procedure (Adjustable Output)

(Continued)

Cap. Ref. Desg. #	Output Capacitor					
	Surface Mount		Through Hole			
	Sprague 594D Series ($\mu\text{F/V}$)	AVX TPS Series ($\mu\text{F/V}$)	Sanyo OS-CON SA Series ($\mu\text{F/V}$)	Sanyo MV-GX Series ($\mu\text{F/V}$)	Nichicon PL Series ($\mu\text{F/V}$)	Panasonic HFQ Series ($\mu\text{F/V}$)
C1	120/6.3	100/10	100/10	220/35	220/35	220/35
C2	120/6.3	100/10	100/10	150/35	150/35	150/35
C3	120/6.3	100/10	100/35	120/35	120/35	120/35
C4	68/10	100/10	68/10	220/35	220/35	220/35
C5	100/16	100/10	100/10	150/35	150/35	150/35
C6	100/16	100/10	100/10	120/35	120/35	120/35
C7	68/10	100/10	68/10	150/35	150/35	150/35
C8	100/16	100/10	100/10	330/35	330/35	330/35
C9	100/16	100/16	100/16	330/35	330/35	330/35
C10	100/16	100/16	68/16	220/35	220/35	220/35
C11	100/16	100/16	68/16	150/35	150/35	150/35
C12	100/16	100/16	68/16	120/35	120/35	120/35
C13	100/16	100/16	100/16	120/35	120/35	120/35
C14	100/16	100/16	100/16	220/35	220/35	220/35
C15	47/20	68/20	47/20	220/35	220/35	220/35
C16	47/20	68/20	47/20	150/35	150/35	150/35
C17	47/20	68/20	47/20	120/35	120/35	120/35
C18	68/25	(2x) 33/25	47/25 (Note 8)	220/35	220/35	220/35
C19	33/25	33/25	33/25 (Note 8)	150/35	150/35	150/35
C20	33/25	33/25	33/25 (Note 8)	120/35	120/35	120/35
C21	33/35	(2x) 22/25	(Note 9)	150/35	150/35	150/35
C22	33/35	22/35	(Note 9)	120/35	120/35	120/35
C23	(Note 9)	(Note 9)	(Note 9)	220/50	100/50	120/50
C24	(Note 9)	(Note 9)	(Note 9)	150/50	100/50	120/50
C25	(Note 9)	(Note 9)	(Note 9)	150/50	82/50	82/50

Note 8: The SC series of Os-Con capacitors (others are SA series)

Note 9: The voltage ratings of the surface mount tantalum chip and Os-Con capacitors are too low to work at these voltages.

FIGURE 17. Output Capacitor Selection Table

Application Information

TYPICAL SURFACE MOUNT PC BOARD LAYOUT, FIXED OUTPUT (4X SIZE)

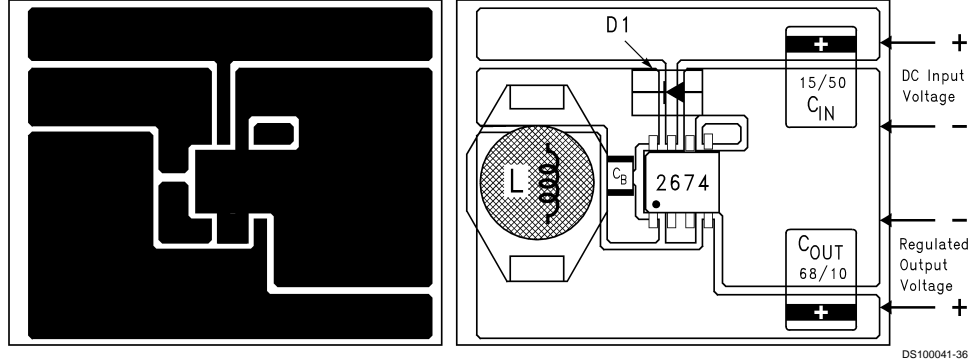

C_{IN} - 15 μ F, 25V, Solid Tantalum Sprague, "594D series"
 C_{OUT} - 68 μ F, 10V, Solid Tantalum Sprague, "594D series"
 D1 - 1A, 40V Schottky Rectifier, Surface Mount
 L1 - 47 μ H, L13, Coilcraft DO3308
 C_B - 0.01 μ F, 50V, Ceramic

TYPICAL SURFACE MOUNT PC BOARD LAYOUT, ADJUSTABLE OUTPUT (4X SIZE)

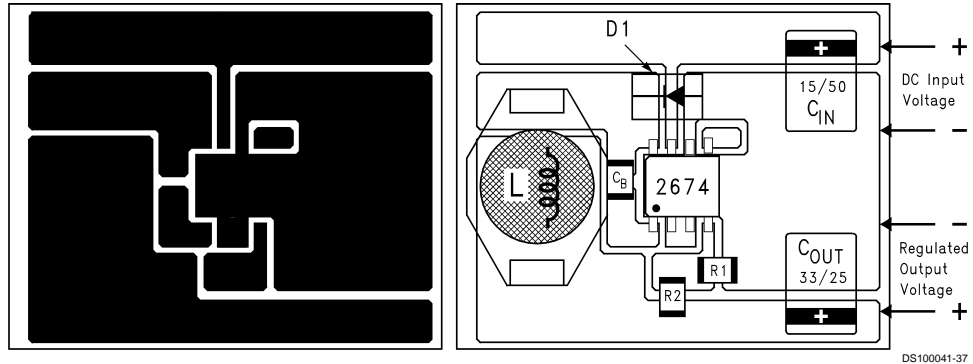

C_{IN} - 15 μ F, 50V, Solid Tantalum Sprague, "594D series"
 C_{OUT} - 33 μ F, 25V, Solid Tantalum Sprague, "594D series"
 D1 - 1A, 40V Schottky Rectifier, Surface Mount
 L1 - 100 μ H, L20, Coilcraft DO3316
 C_B - 0.01 μ F, 50V, Ceramic
 R1 - 1k, 1%
 R2 - Use formula in Design Procedure

FIGURE 18. PC Board Layout

Layout is very important in switching regulator designs. Rapidly switching currents associated with wiring inductance can generate voltage transients which can cause problems. For minimal inductance and ground loops, the wires indicated by **heavy lines (in Figure 2 and Figure 3) should be wide printed circuit traces and should be kept as short as possible.** For best results, external components should be located as close to the switcher IC as possible using ground plane construction or single point grounding.

If **open core inductors are used**, special care must be taken as to the location and positioning of this type of inductor. Allowing the inductor flux to intersect sensitive feedback, IC ground path, and C_{OUT} wiring can cause problems.

When using the adjustable version, special care must be taken as to the location of the feedback resistors and the associated wiring. Physically locate both resistors near the IC, and route the wiring away from the inductor, especially an open core type of inductor.

Physical Dimensions inches (millimeters) unless otherwise noted

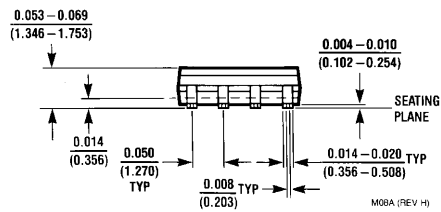
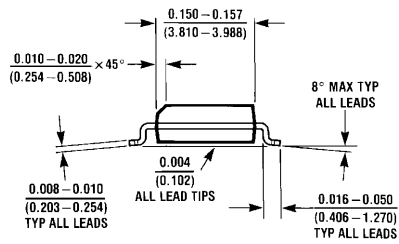
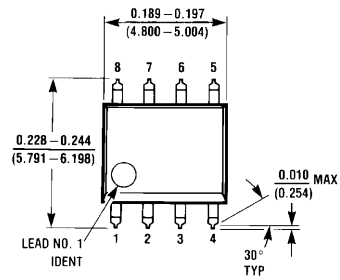

8-Lead (0.150" Wide) Molded Small Outline Package, JEDEC
Order Number LM2674M-3.3, LM2674M-5.0,
LM2674M-12 or LM2674M-ADJ
NS Package Number M08A

LM2674 SIMPLE SWITCHER Power Converter High Efficiency 500 mA Step-Down Voltage Regulator

Physical Dimensions inches (millimeters) unless otherwise noted (Continued)

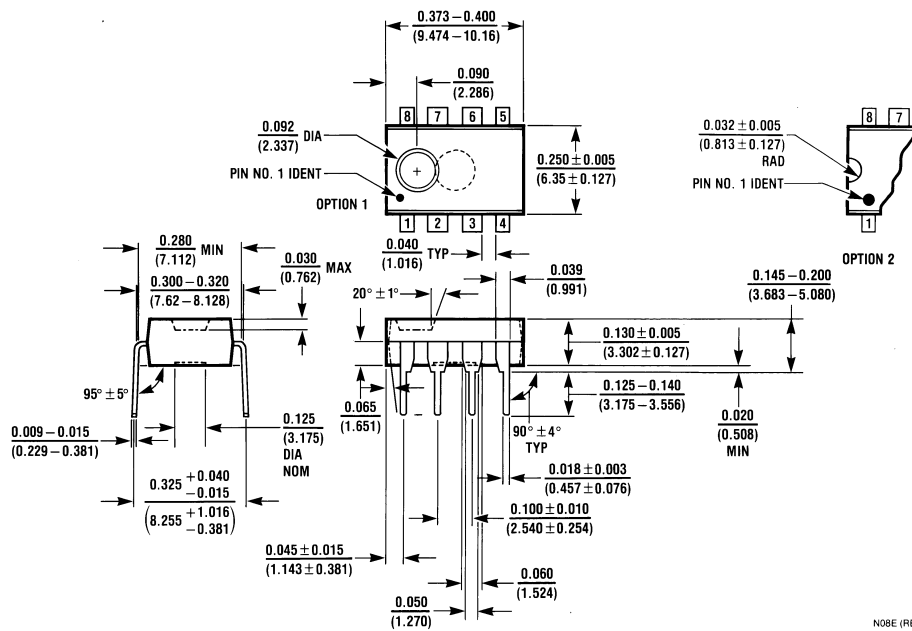

8-Lead (0.300" Wide) Molded Dual-In-Line Package
Order Number LM2674N-3.3, LM2674N-5.0,
LM2674N-12 or LM2674N-ADJ
NS Package Number N08E

N08E (REV F)

LIFE SUPPORT POLICY

NATIONAL'S PRODUCTS ARE NOT AUTHORIZED FOR USE AS CRITICAL COMPONENTS IN LIFE SUPPORT DEVICES OR SYSTEMS WITHOUT THE EXPRESS WRITTEN APPROVAL OF THE PRESIDENT AND GENERAL COUNSEL OF NATIONAL SEMICONDUCTOR CORPORATION. As used herein:

1. Life support devices or systems are devices or systems which, (a) are intended for surgical implant into the body, or (b) support or sustain life, and whose failure to perform when properly used in accordance with instructions for use provided in the labeling, can be reasonably expected to result in a significant injury to the user.
2. A critical component is any component of a life support device or system whose failure to perform can be reasonably expected to cause the failure of the life support device or system, or to affect its safety or effectiveness.

National Semiconductor Corporation
Americas
Tel: 1-800-272-9959
Fax: 1-800-737-7018
Email: support@nsc.com

National Semiconductor Europe
Fax: +49 (0) 1 80-530 85 86
Email: europe.support@nsc.com
Deutsch Tel: +49 (0) 1 80-530 85 85
English Tel: +49 (0) 1 80-532 78 32
Français Tel: +49 (0) 1 80-532 93 58
Italiano Tel: +49 (0) 1 80-534 16 80

National Semiconductor Asia Pacific Customer Response Group
Tel: 65-2544466
Fax: 65-2504466
Email: sea.support@nsc.com

National Semiconductor Japan Ltd.
Tel: 81-3-5639-7560
Fax: 81-3-5639-7507

www.national.com

National does not assume any responsibility for use of any circuitry described, no circuit patent licenses are implied and National reserves the right at any time without notice to change said circuitry and specifications.